	PAGE TITLE: Power diagram	CLIENT: SHELLY EUROPE LTD.	NAME	DATE	FUNCTION & LOCATION:	PAGE: 1
	PANEL NAME FW+QA Control panel	PROJECT: KNX Integration into SHELLY devices	DRAWN: Evgeniy Georgiev	13.6.2024	.	OF: 7
	DRAWING No:	SIZE: A4	FILENAME C:\Program Files (x86)\IGE+XAO\SEE Electrical V7R2\Projects\Shelly FW+QA Panel.sep	CHECKED: Evgeniy Georgiev		13.6.2024
			REVISION: 001	17.6.2024 . 16:54:16		

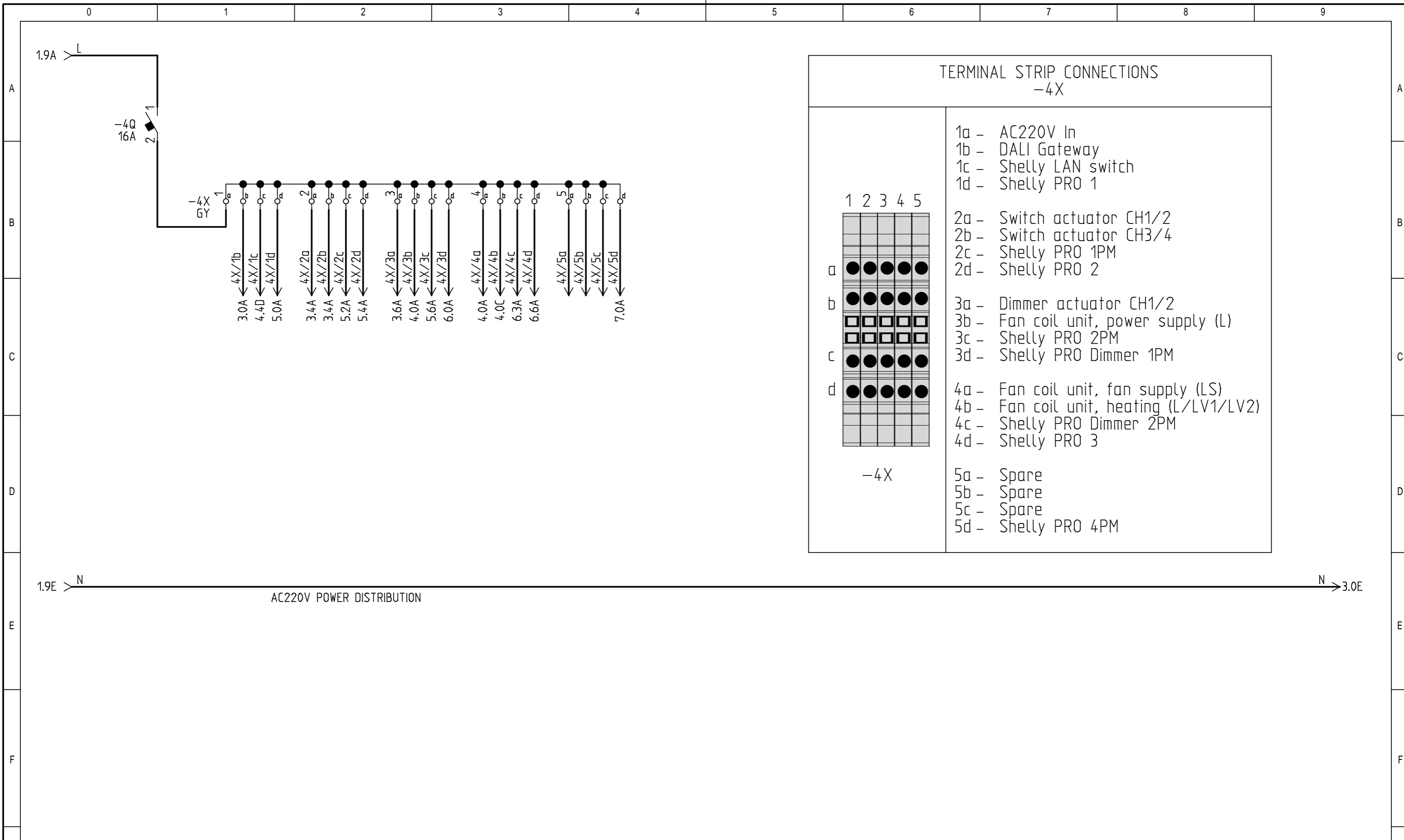

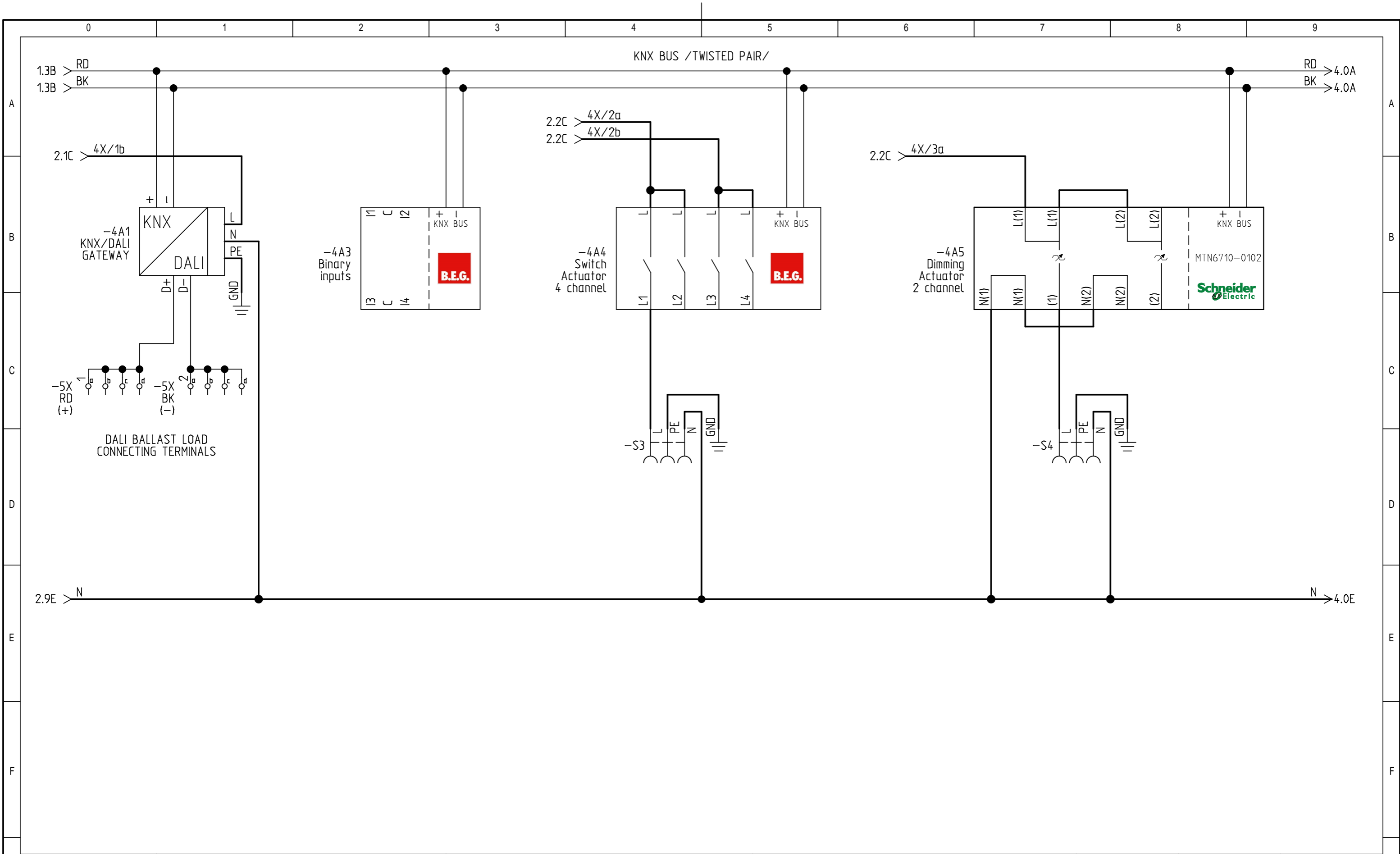

PAGE TITLE: Power diagram		CLIENT: SHELLY EUROPE LTD.		NAME	DATE	FUNCTION & LOCATION:	PAGE: 2
PANEL NAME FW+QA Control panel		PROJECT: KNX Integration into SHELLY devices		DRAWN: Evgeniy Georgiev	13.6.2024	.	OF: 7
DRAWING No:		FILENAME C:\Program Files (x86)\IGE+XAO\SEE Electrical V7R2\Projects\Shelly FW+QA Panel.sep		CHECKED: Evgeniy Georgiev	13.6.2024		
SIZE: A4				REVISION: 001	17.6.2024		16:54:16





	PAGE TITLE: Power diagram	CLIENT: SHELLY EUROPE LTD.	NAME	DATE	FUNCTION & LOCATION:	PAGE: 3
	PANEL NAME FW+QA Control panel	PROJECT: KNX Integration into SHELLY devices	DRAWN: Evgeniy Georgiev	13.6.2024	.	OF: 7
	DRAWING No:	SIZE: A4	FILENAME: C:\Program Files (x86)\IGE+XAO\SEE Electrical V7R2\Projects\Shelly FW+QA Panel.sep	CHECKED: Evgeniy Georgiev		13.6.2024
			REVISION: 001	17.6.2024 . 16:54:16		

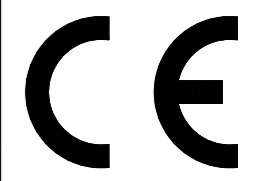

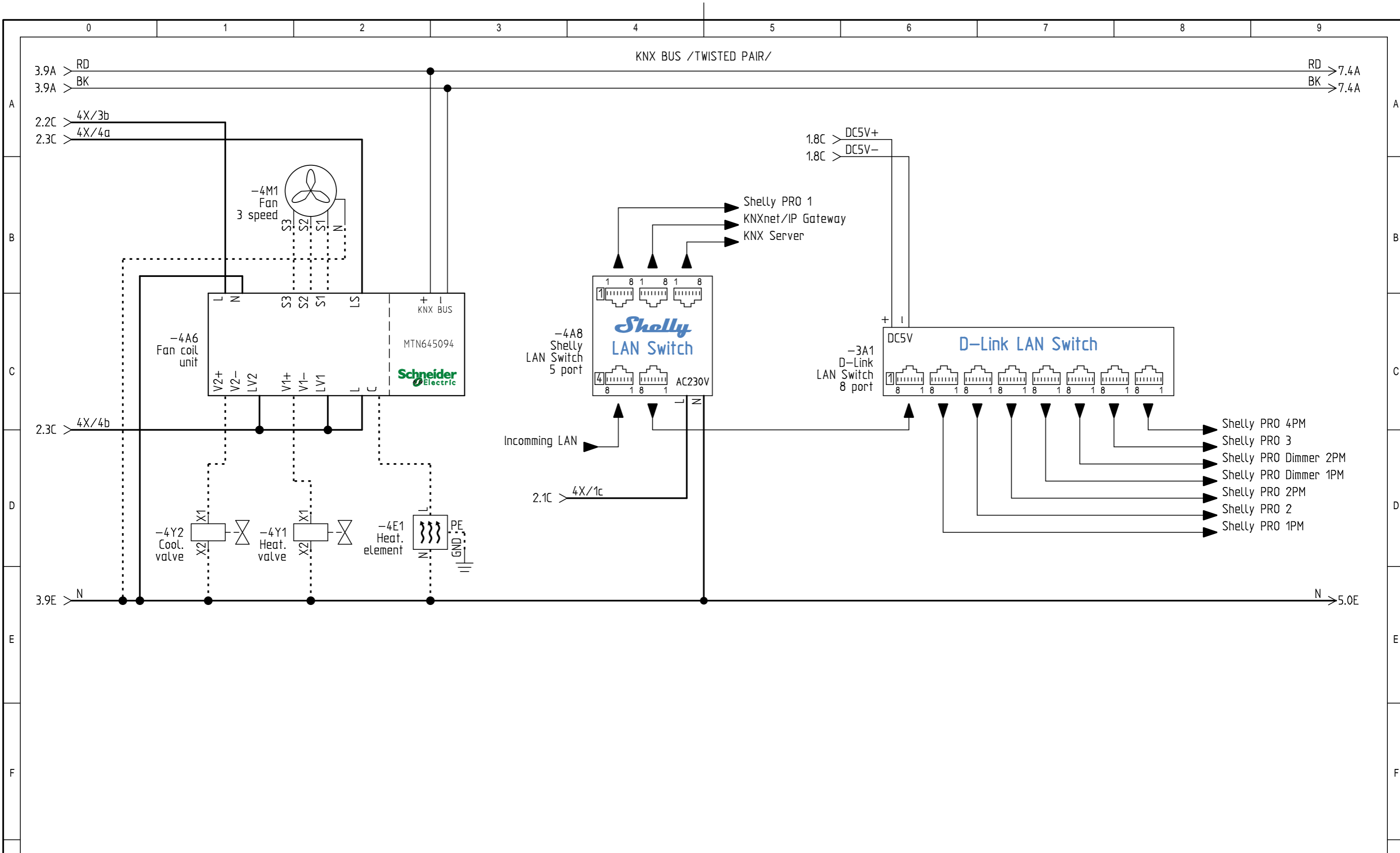

PAGE TITLE: Power diagram PANEL NAME: FW+QA Control panel DRAWING No:	CLIENT: SHELLY EUROPE LTD. PROJECT: KNX Integration into SHELLY devices FILENAME: C:\Program Files (x86)\IGE+XAO\SEE Electrical V7R2\Projects\Shelly FW+QA Panel.sep	NAME	DATE	FUNCTION & LOCATION: PAGE: 4 OF: 7
		DRAWN: Evgeniy Georgiev	14.6.2024	
		CHECKED: Evgeniy Georgiev	14.6.2024	
		REVISION: 001	17.6.2024 . 17:02:34	

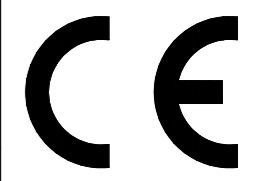

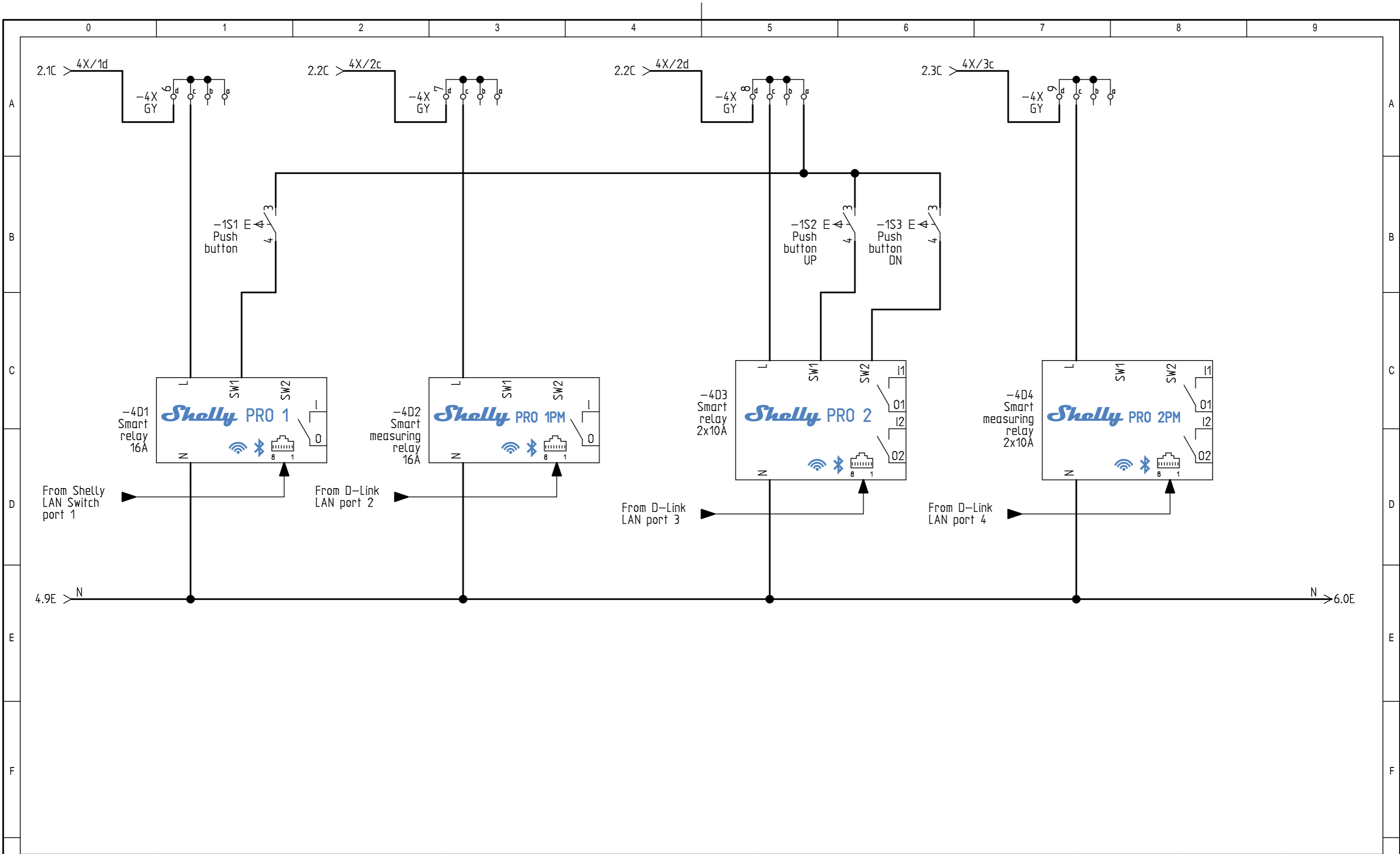

PAGE TITLE: Power diagram PANEL NAME: FW+QA Control panel DRAWING No.:	CLIENT: SHELLY EUROPE LTD. PROJECT: KNX Integration into SHELLY devices FILENAME: C:\Program Files (x86)\IGE+XAO\SEE Electrical V7R2\Projects\Shelly FW+QA Panel.sep	NAME	DATE	FUNCTION & LOCATION: PAGE: 5 OF: 7
		DRAWN: Evgeniy Georgiev	14.6.2024	
		CHECKED: Evgeniy Georgiev REVISION: 001	14.6.2024 . 16:55:33 17.6.2024 . 16:55:33	



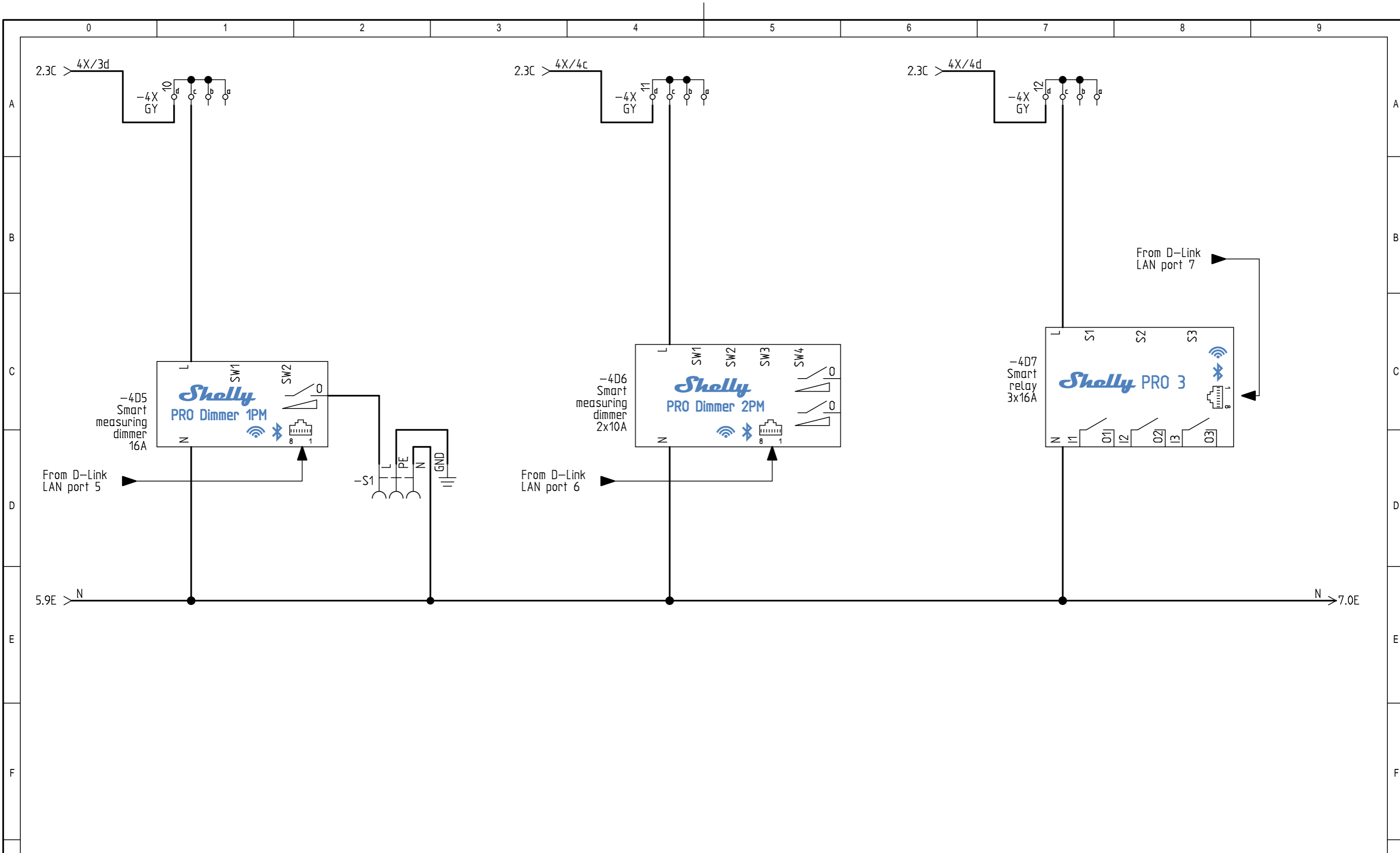

PAGE TITLE: Power diagram PANEL NAME: FW+QA Control panel DRAWING No:	CLIENT: SHELLY EUROPE LTD. PROJECT: KNX Integration into SHELLY devices FILENAME: C:\Program Files (x86)\IGE+XAO\SEE Electrical V7R2\Projects\Shelly FW+QA Panel.sep	NAME	DATE	FUNCTION & LOCATION:	PAGE: 6
		DRAWN: Evgeniy Georgiev	17.6.2024		OF: 7
		CHECKED: Evgeniy Georgiev	17.6.2024	REVISION: 001	17.6.2024 16:55:33

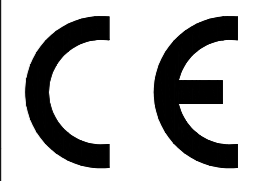

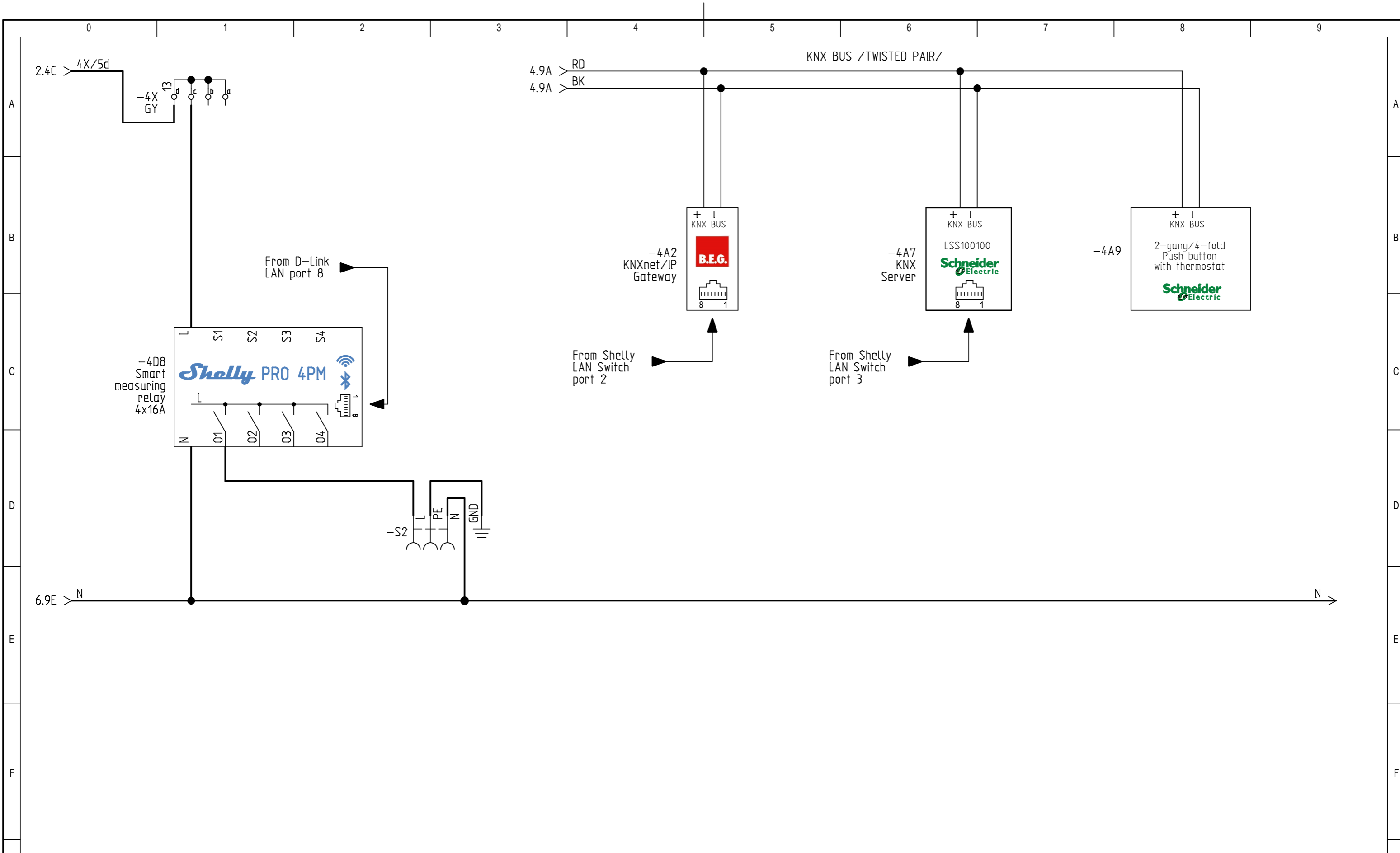

PAGE TITLE: Power diagram		CLIENT: SHELLY EUROPE LTD.		NAME	DATE	FUNCTION & LOCATION:	PAGE: 7
PANEL NAME FW+QA Control panel		PROJECT: KNX Integration into SHELLY devices		DRAWN: Evgeniy Georgiev	17.6.2024		OF: 7
DRAWING No:		SIZE: A4	FILENAME C:\Program Files (x86)\IGE+XAO\SEE Electrical V7R2\Projects\Shelly FW+QA Panel.sep				
			REVISION: 001	17.6.2024 . 17:02:47			

